

INSTRUCȚIUNI MONTAJ INNOTECH ATIRA

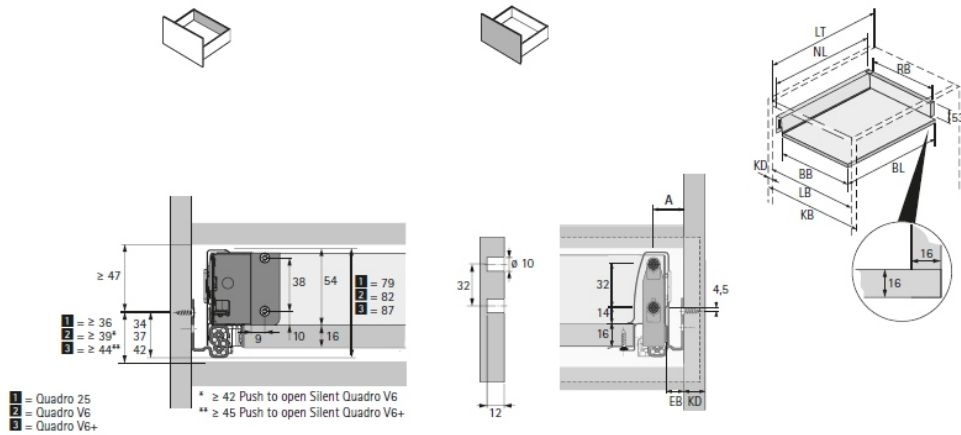

Cote pentru debitare / montaj - H54mm



| | | | Dimensiune | | mm |
|------------------------|---------------------------|------------------------|------------|---------------|-----------------------|
| BB Lățime fund sertar | RB Lățime spate sertar | LB Lățime interioară | KD | 16 18 19 | BL NL + 10 |
| BL Lungime fund sertar | NL Lungime nominală | LT Adâncime interioară | EB | 12,5 10,5 9,5 | BB LB - 2 x EB - 51,5 |
| KB Lățime corp | KD Grosimea laterală corp | EB Lățime de montaj | A | 23 21 20 | RB LB - 2 x EB - 63 |

Poziții pentru fixarea gliserei Quadro V6

| Lungime nominală mm | Linie de găuri b1 mm |
|---------------------|----------------------|
| 260 | 160 |
| 300 | 160 |
| 350 | 160 |
| 420 | 224 |
| 470 | 256 |
| 520 | 256 |

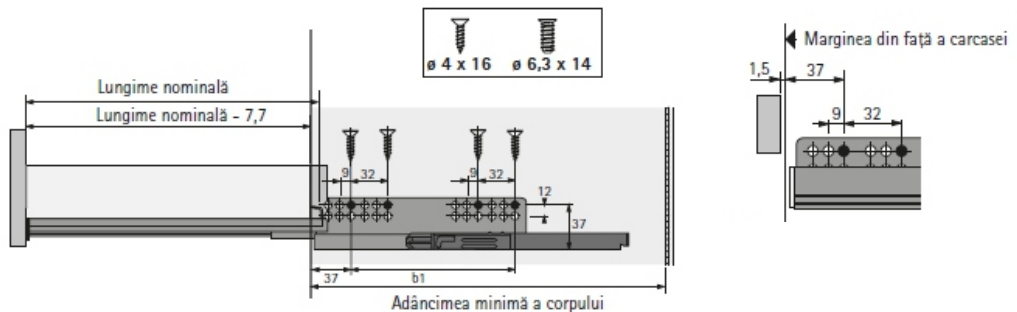

Accesorii montaj

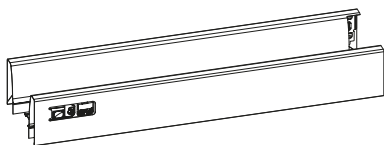

Laterală sertar,
înălțime 54mm

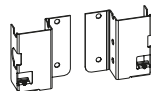

Conectori spate sertar

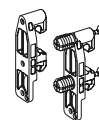

Conectori pentru
laterală front



Capace acoperire

Cote pentru debitare / montaj - H70mm

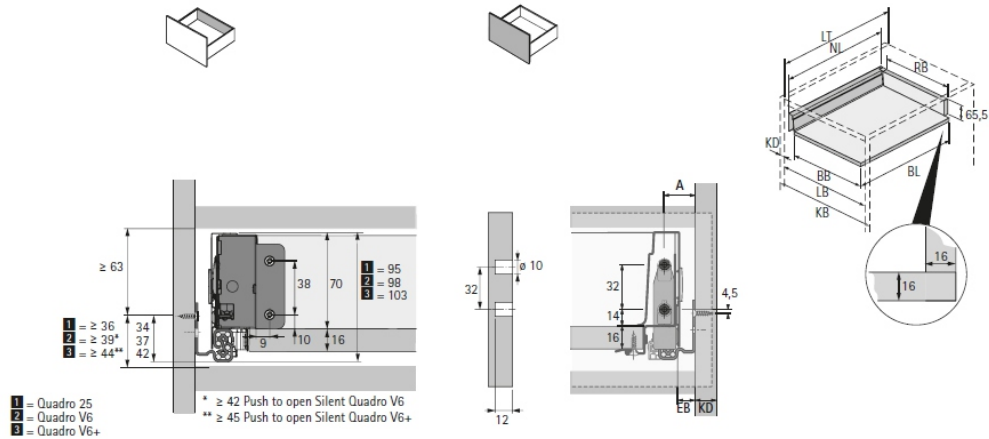

| | | | Dimensiune | | mm | |
|------------------------|---------------------------|------------------------|------------|--------------------|------|-----|
| BB Lățime fund sertar | RB Lățime spate sertar | LB Lățime interioară | KD | 16 | 18 | 19 |
| BL Lungime fund sertar | NL Lungime nominală | LT Adâncime interioară | EB | 12,5 | 10,5 | 9,5 |
| KB Lățime corp | KD Grosimea laterală corp | EB Lățime de montaj | A | 23 | 21 | 20 |
| | | | BL | NL +10 | | |
| | | | BB | LB - 2 x EB - 51,5 | | |
| | | | RB | LB - 2 x EB - 63 | | |

Poziții pentru fixarea glisierii Quadro V6

| Lungime nominală mm | Linie de găuri b1 mm |
|---------------------|----------------------|
| 260 | 160 |
| 300 | 160 |
| 350 | 160 |
| 420 | 224 |
| 470 | 256 |
| 520 | 256 |

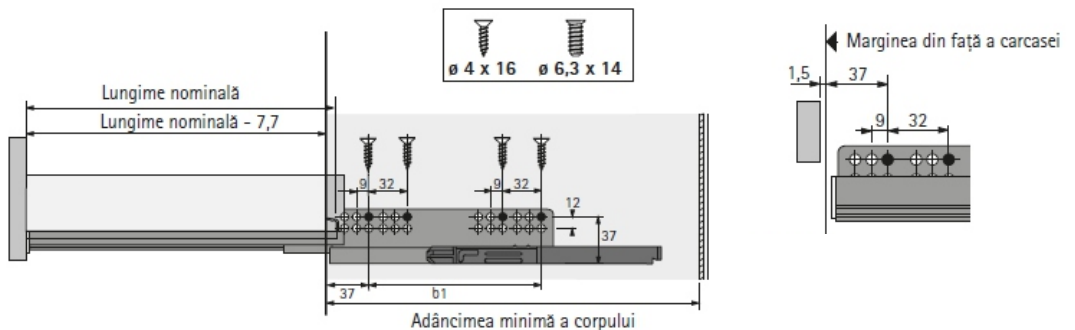

Accesorii montaj

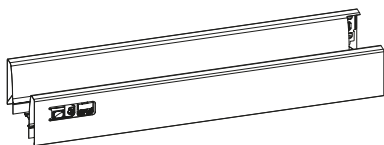

Laterală sertar,
înălțime 70 mm

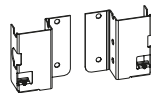

Conectori spate sertar

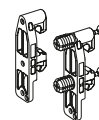

Conectori pentru laterală front



Capace acoperire

Cote pentru debitare / montaj - H144mm

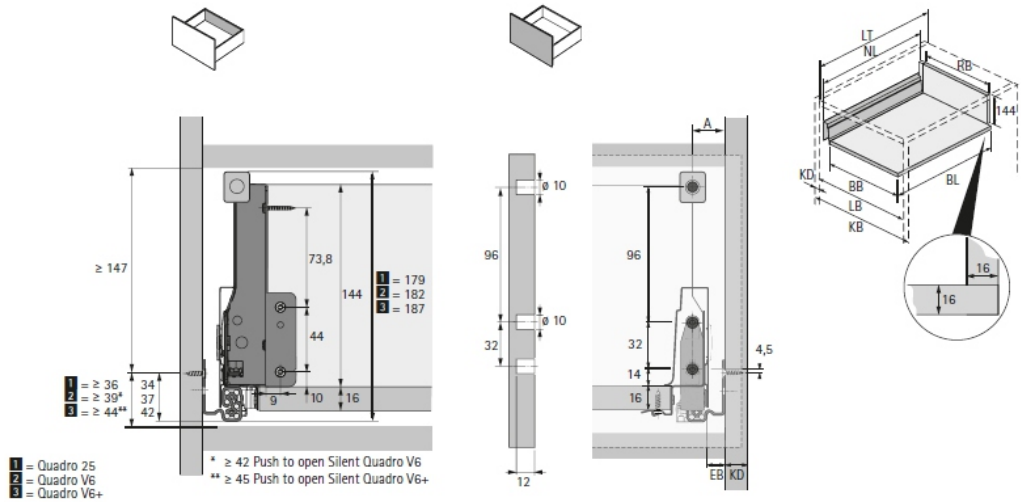

| | | |
|------------------------|---------------------------|------------------------|
| BB Lățime fund sertar | RB Lățime spate sertar | LB Lățime interioară |
| BL Lungime fund sertar | NL Lungime nominală | LT Adâncime interioară |
| KB Lățime corp | KD Grosimea laterală corp | EB Lățime de montaj |

| | | | |
|----|------|------|-----|
| KD | 16 | 18 | 19 |
| EB | 12,5 | 10,5 | 9,5 |
| A | 23 | 21 | 20 |

| Dimensiune | mm |
|------------|--------------------|
| BL | NL + 10 |
| BB | LB - 2 x EB - 51,5 |
| RB | LB - 2 x EB - 63 |

Poziții pentru fixarea gliserei Quadro V6

| Lungime nominală mm | Linie de găuri b1 mm |
|---------------------|----------------------|
| 260 | 160 |
| 300 | 160 |
| 350 | 160 |
| 420 | 224 |
| 470 | 256 |
| 520 | 256 |

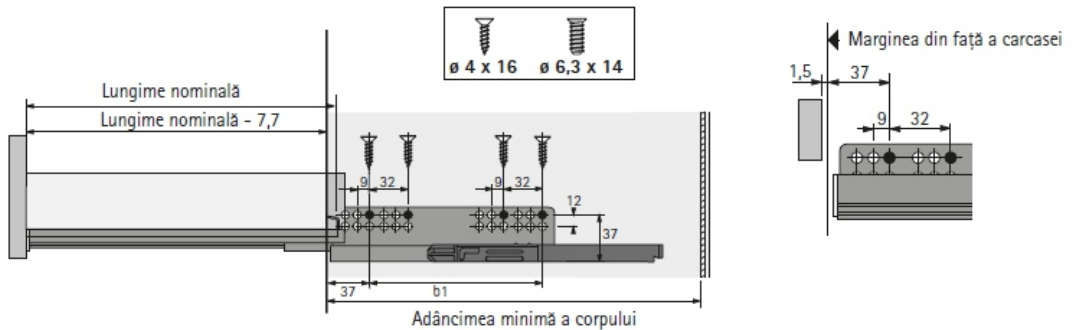

Elemente componentă sertar

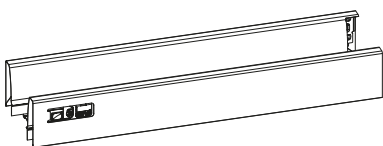

Laterală sertar,
înălțime 70 mm

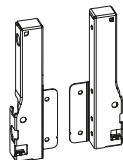

Conectori spate
sertar

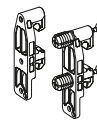

Conectori pentru
laterală front



Conectori front
pentru lonjeron

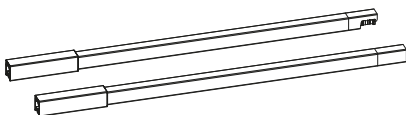

Lonjeron



Capace acoperire

Cote pentru debitare / montaj - H176mm

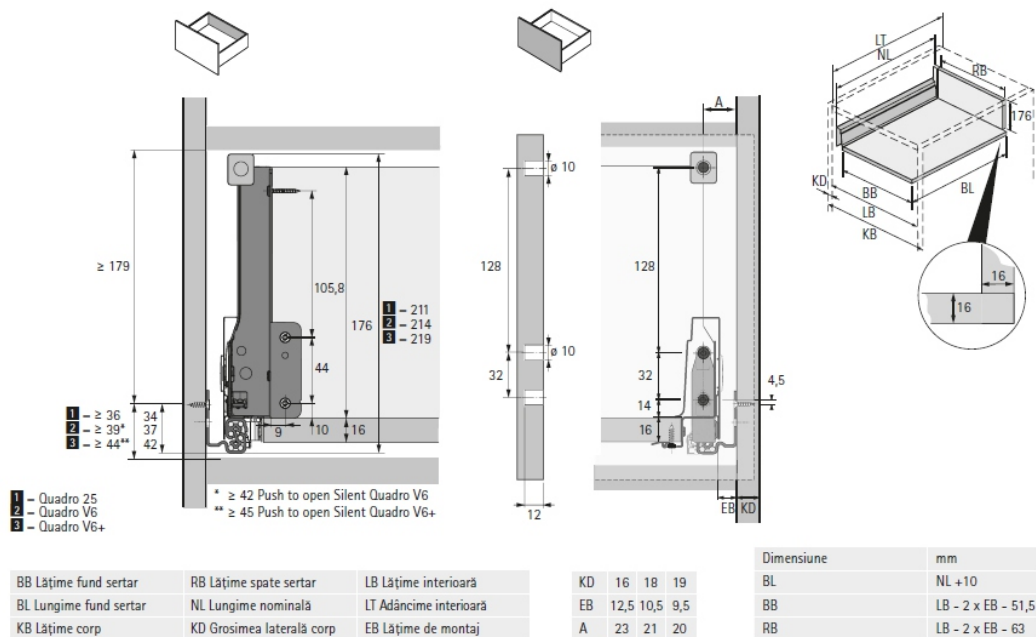

Poziții pentru fixarea glisierii Quadro V6

| Lungime nominală mm | Linie de găuri b1 mm |
|---------------------|----------------------|
| 260 | 160 |
| 300 | 160 |
| 350 | 160 |
| 420 | 224 |
| 470 | 256 |
| 520 | 256 |

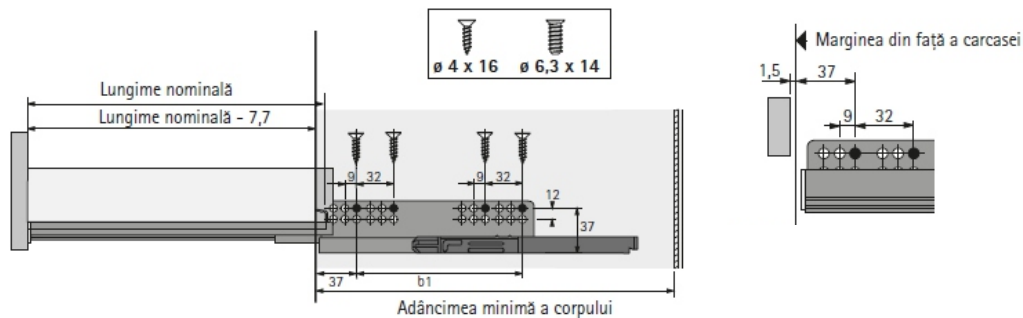

Elemente componentă sertar

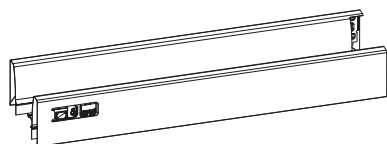

Laterală sertar,
înălțime 70 mm

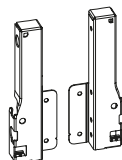

Conectori spate
sertar

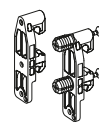

Conectori pentru
laterală front



Conectori front
pentru lonjeron

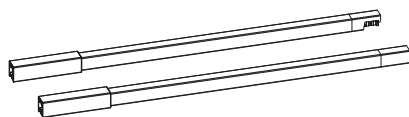

Lonjeron



Capace acoperire